

HENGSTLER

Operating Manual

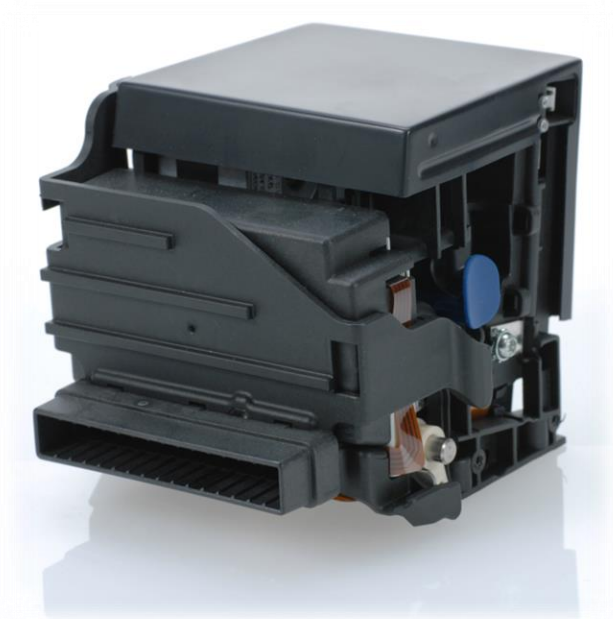

eXtendo[®]
Thermal Printer Family

Models: X-56 and X-80

E

© 2008-2022 by HENGSTLER

Hengstler GmbH has created the text and diagrams contained in this document with care. However, we cannot accept responsibility for any errors or omissions. Notification regarding any errors and suggestions for improvement are welcome. We reserve the right to make technical and other changes at any time in the interest of continual product development.

All information contained in this manual is given without regard to any possible patent protection.

All rights reserved. Reproduction, translation and/or distribution of this document, or extracts thereof, are permitted only by express authorization from Hengstler GmbH. The Hengstler name, “eXtendo” and the Hengstler logo are registered trademarks of Hengstler GmbH and the Danaher Corporation. “Windows” and “Microsoft” are registered trademarks of Microsoft Corporation. Other brand and product names are trademarks or registered trademarks of their respective companies.

HENGSTLER GmbH

Uhlandstraße 49

78554 Aldingen

Germany

Tel. +49 (0) 7424-89 0

Fax +49 (0) 7424-89 500

e-mail : info@hengstler.com

www.hengstler.com

Document History

Revision	Date	Init	Status	Description
1.00	2008 Jan 28	CBL	Closed	Initial version
1.01	2008 Mar 31	CBL	Closed	Removed excessive warranty value entries under “Features Selected at Time of Order”. Corrected figure ref. no. under Wiring, Interfacing. Removed “Heading” format for word “Serial” under Wiring, Interfacing.
1.02	2008 June 27	CBL	Closed	Add note re 15 mm minimum paper length. Removed Basic Firmware option and 130 mm/sec option. Add print speed of 130 mm/sec max. for 12/10-36 VDC models. Change 10-39 VDC to 10-36 VDC. Change Printhead Position description to describe three positions. Troubleshooting section expanded. Black Mark text clarified. Cutter Operation text clarified. Change sleep mode current spec to 50µA.
1.03	2009 Jan 25	CBL	Closed	Corrected formatting of columns in serial and USB cable pinout tables. Company logo changed from graphics to text. Add duty-cycle specification. Add photo of USB and Multi-voltage version for connector positioning. Add description of connectors on gear side. Modify paper roll holder text. Modify text to match new photos. Add note re specifications under Power Supply section. Update paper roll holders in option chart. Added paper roll holder drawing reference. Add schematic fragment for PVE/Aux. sensor connection. Add registered trademark symbol (®) to “eXtendo”.
1.04	2009 Feb 20	CBL	Closed	Revise printhead position to two positions (three positions used in prototypes only). Add “printhead up” status to LED Indicators. Revise Head Status Sensor to reflect no printing when printhead is up. Troubleshooting section revised re printhead up operation. Added printing current specs under Technical Specifications.
1.05	2009 May 15	CBL	Closed	Add section on low current operation. Add FCC Part 15 statement. Add EN55022, EN55024 statements. Add two “General Information” points. Add “Function” section. Add cable length limitation to interface specs. Add warning with photo about damaging cutter bracket when improperly mounted. Remove “Available soon” from Linux driver reference in intro. Add fanfold paper reference in “Paper” section. Add explanation for moving cutter blades manually.
1.06	2010 July 19	CBL	Closed	Add note about no serial handshaking with sleep mode. Add explanation of chute sensor/partial-cut. Add mounting hole diagram and expand mounting comments. Update cover photo. Add installation of paper guide.
1.07	2011 April 21	CBL	Closed	Changed P/N of paper spec document. Correct voltage in print speed specifications. Increase 24 VDC print speed to 350 mm/sec.
1.08	2012 Aug. 8	CBL	Closed	Add clarifying statement re Class B emissions. Add statement about sunlight on chute sensor. Add definition of area in line with black mark where only certain inks may be used. Added drawing of PPE sensor.
1.09	2015 Oct. 5	Eli	Closed	Serial data cable pinout corrected. 12V and 10-36V options removed for X-80. Sensor position 3 in X-56 moved left.
1.10	2019 Sep. 12	Eli	Closed	Updating photographs; various corrections, formatting. Added: polarity information, cutter types, spares, accessories, hints for grounding and more. Removed multi-volt options.
1.11	2020 April 23	HW	Closed	USB 1.1 to USB 2.0
1.12	2022 June 30	Eli	Closed	Added grounding warning; 2D barcodes added; updated repair data; new drawing for paper low sensor mounting; updated technical specifications (life and EMC)

Table of Contents

1.	Introduction	6
1.1.	Additional Documentation	6
2.	Important Information and Safety Instructions	7
2.1.	Systems Specific Safety Instructions and Symbols	7
2.2.	General Information	8
3.	Overview	9
3.1.	Overview of Thermal Printing Technology	9
3.2.	X-56 versus X-80	9
3.3.	Functional View	10
3.4.	Description of Components and Operation	10
3.5.	Location of Controls and Connectors	11
3.6.	Operation of Sensors and LEDs	12
3.6.1.	Paper Entrance / Black Mark Sensor	12
3.6.2.	Paper Pre-End (Paper Low) Sensor Option	13
3.6.3.	LED Indicators.....	14
3.6.4.	Printhead Status Sensor	15
3.6.5.	Chute/Jam Sensor	15
3.7.	Graphic Printing vs. Printing with Printer's Fonts	16
3.8.	Features Selected at Time of Order	16
5.	Installation	17
5.1.	Unpacking	17
5.2.	Function	17
5.3.	Mounting Printer	18
5.4.	Installing Paper Guides.....	19
5.5.	Wiring.....	20
5.5.1.	Power	20
5.5.2.	Data Interfacing	20
5.6.	Paper Supply	22
5.6.1.	Hengstler Paper Roll Holders	22
5.6.2.	Designing Your Own Paper Roll Holder	22
5.7.	Power Supply Specifications.....	23
5.8.	Electrical Design Aspects	23
6.	Operation.....	24
6.1.	Loading Paper.....	24
6.2.	Printhead Position Control	24
6.3.	Paper Advance Wheel.....	24
6.4.	Print Speed	25
6.5.	Cutter Operation.....	25
6.5.1.	Partial Cut with Chute Sensor	25
6.6.	eXtendo® Digital Tools.....	26
7.	Low Current Operation	27
7.1.	Print Speed	27
7.2.	Graphics/Bar Codes.....	27
7.3.	Inverse Printing.....	27
7.4.	Dot History Factor	27
7.5.	Multi-Strobe Factor	27
7.6.	Print Density Adjustment.....	27
8.	Troubleshooting	28
9.	Maintenance.....	28
10.	Repair and Support	28
11.	Buying Paper	29
11.1.	Sourcing Paper	29

- 11.2. Converting Paper 29
- 11.3. Black Mark Sensor Locations 29
- 12. Technical Specifications 31
 - 12.1. General Specifications (X-56 and X-80) 31
 - 12.2. X-56 Specifications 32
 - 12.3. X-80 Specifications 32
 - 12.4. Electromagnetic Compatibility 33
 - 12.4.1. FCC Part 15 Class B Device 33
 - 12.4.2. EN55022 – Emissions 33
 - 12.4.3. EN55024 – Electromagnetic Susceptibility 33
- 13. Spare Parts and Accessories 34

1. Introduction

Thank you for selecting the Hengstler eXtendo® Thermal Printer! We are proud of this feature-rich product, which was designed using all our expertise and experience, and we are confident that you will be pleased with the advanced features and outstanding performance.

This Operator Manual is designed to help you with the proper installation, connection to your host computer system and start-up of the eXtendo® thermal printer system. All necessary details will be explained in the following sections. Please read this manual carefully before using the printer. If you have any further questions, please do not hesitate to contact us.

The eXtendo® thermal printer family does not require any servicing and is intended primarily for printing and cutting documents and receipts from continuous thermal paper. The X-56 version is for narrower paper (49 – 60 mm), while the X-80 handles wider paper (60 – 86 mm). Various paper cutters are available to handle a wide range of paper stocks up to 250 g/m² and more. Powerful motors allow the use of large paper rolls to maximize time between paper replenishment. If documents are to be printed on preprinted forms or with a predetermined length, 'Black Mark' control is available. The horizontal and vertical print density is 203 dpi so that graphics, such as logos etc. can be printed with good quality.

The eXtendo® printer family has been designed for use in a wide variety of applications, including ticketing, parking, banking, transit, reverse-vending, kiosk, car wash, fuel dispensing, and vending applications. In order to provide the optimal cost/benefit ratio, the eXtendo® family of printers allows you to choose and buy only the features that you need for your application! This extreme customization insures that you have just the right amount of printer for your task; not too much, and not too little.

Available in both USB and Serial (RS-232) configurations, the eXtendo® printer family is one of the most versatile we've ever produced! Driver software is available that supports Windows and Linux operating systems. In addition, the printer can also be operated directly in ASCII mode through ESC sequences a detailed description of which can be found in the eXtendo® Emulation Command Set Reference.

We're glad you chose the eXtendo® thermal printer family. Once you've used it, we're sure you will be, too!

1.1. Additional Documentation ¹

Document No.	Description
D 684 112	eXtendo® Emulation Command Set Reference
D 684 128	eXtendo® Paper Specification
D 684 090	X-56 Dimensional Drawing – Twincut Cutter
D 684 098	X-56 Dimensional Drawing – Rotary Cutter
D 684 091	X-80 Dimensional Drawing – Twincut Cutter
D 684 099	X-80 Dimensional Drawing – Rotary Cutter
D 684 152	100 mm Paper Roll Holder Drawing
D 684 154	150 mm Paper Roll Holder Drawing

¹ All listed documents can be found in the download area on our webpage under Thermal Printers. If any of these are missing, please contact our technical support (→ section "10 Repair and Support").

2. Important Information and Safety Instructions

Hengstler GmbH accepts no liability for any damages, direct, indirect or consequential, arising from improper use of this thermal printer, and, in particular, due to non-compliance with this operating manual or any other available documentation or due to improper handling or maintenance. Should Hengstler GmbH choose to make technical documentation available, this does not imply any authorization, implied or stated, for the making additions, repairs or modifications to this printer.

This documentation may not be copied, nor shall its contents be disclosed or used commercially unless such use has otherwise been explicitly agreed to by a duly authorized Hengstler representative in writing.

The user is responsible for proper handling and installation of this printer. The printer should only be shipped in its original packing.

2.1. *Systems Specific Safety Instructions and Symbols*

The following symbols on the system and in the manual remind you to follow the relevant safety instructions:



General warning for cases where the user or a service person may be in danger.











General notes and hints for operating the system safely.



Cross Reference

2.2. General Information

Hengstler GmbH accepts no liability for the safe operation of the eXtendo® thermal printer family unless Hengstler original products are used exclusively and the following instructions and recommendations are heeded.

-  Connect the printer closely to the power supply to minimize ground level rise during high-current-draw printing. Connect the host signal GND closely to the printer GND (star topology).
Note: Different GND levels between host and printer can lead to high compensating currents through the data cable which can impact the data transmission or even damage printer or host electronics. If you cannot provide sufficient grounding, consider using appropriate data port isolators.
-  The DC power connector must not be plugged in or disconnected under load to avoid damage to the electrical components and the thermal printhead.
-  If unauthorized persons perform any repairs or modifications to the printer mechanism and the controller, HENGSTLER will not accept any liability and the guarantee shall be void.
-  Unapproved types of thermal paper may dramatically reduce the life of the print head and may cause the guarantee to expire. For pre-printed thermal paper make sure that only appropriate inks are used. Details can be found in the Hengstler Paper Specifications document D 684 122.
-  Avoid strong vibration, shock, and impact since they may damage or destroy sensitive electronic and mechanical components. Do not touch the surface of the printer control board in order to prevent static electricity from damaging sensitive components.
-  This thermal printer must not be used near to high-frequency apparatus or strong magnetic fields to prevent undefined magnetic disturbance.
-  Do not make any attempts to service this printer (e.g., change paper) while the printer is printing.
-  Installing or uninstalling the printer must only be done while using adequate ESD protection.

3. Overview

3.1. Overview of Thermal Printing Technology

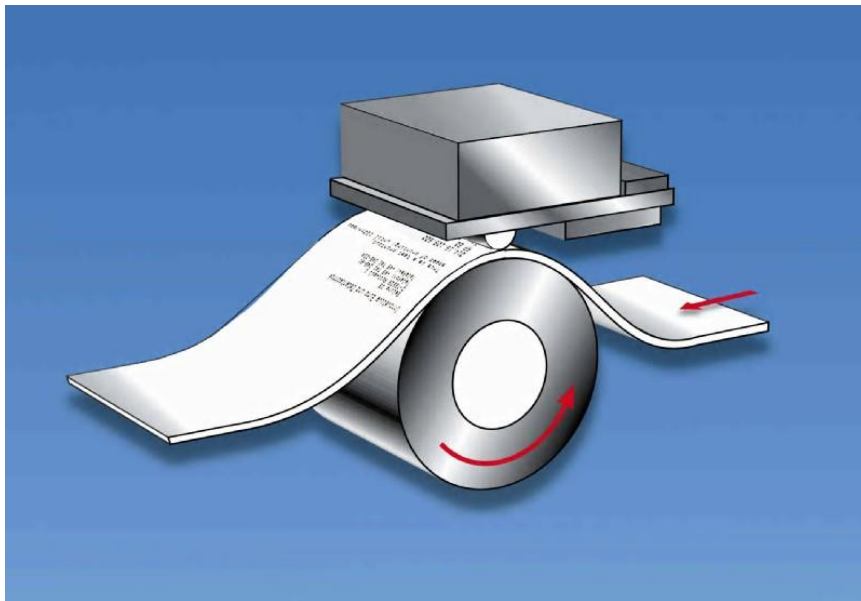

A brief overview of thermal printer technology might be helpful to understand how the eXtendo® thermal printer family works. In most direct thermal printers, paper is fed over a soft, rotating platen and under the thermal printhead. The platen acts as a roller to advance the paper at the same time it acts as a surface against which the spring-loaded printhead presses the paper to insure good thermal conductivity. Circuitry in the printer determines which heating elements to activate (“fire” or “burn”) to form the next row of dots on the paper.

The thermal paper is coated with several compounds. At room temperature, these compounds are white in color and do not react with each other. The heat from the thermal printhead acts as a catalyst in the areas where the small printhead dots are fired, causing these compounds to react with each other and form a new compound which is a contrasting color, usually black. The platen then advances the paper to the position of the next dot row, and the process is repeated.

You may immediately recognize several of the advantages of thermal printing. First, since the printing is done with heat, there is no noise from the printing process itself. Thermal printing is inherently quiet compared to most other technologies, such as impact dot matrix. Also, there is only one moving element in the thermal printer: the platen. This provides increased reliability and life when compared to other technologies.

3.2. X-56 versus X-80

The X-56 and X-80 thermal printers are based on a single design concept and share many components. The difference between them is primarily in the width of paper that they will print and cut. The X-56 handles paper of between 49 and 60 mm in width, while the X-80 accepts paper from 60 to 86 mm wide. Narrower paper than the widest specified above is accommodated using paper guides to provide additional positional guidance.

This causes one specific minor difference between the two printers. The maximum paper width the X-56 will accept is 60 mm, and paper guides are not needed for paper in this width range. 58 mm and 60 mm paper widths are very common, and are considered standards. Paper guides are not needed to handle these two paper widths.

The X-80 has a maximum paper width of 86 mm. While 86 mm wide paper may sometimes be used, the most common larger paper widths are 80 mm and 82.5 mm (3¼ inches). These **do** require a paper guide to use. Therefore the X-80 is always shipped with paper guides, since they are needed for the most common paper widths.

3.3. Functional View

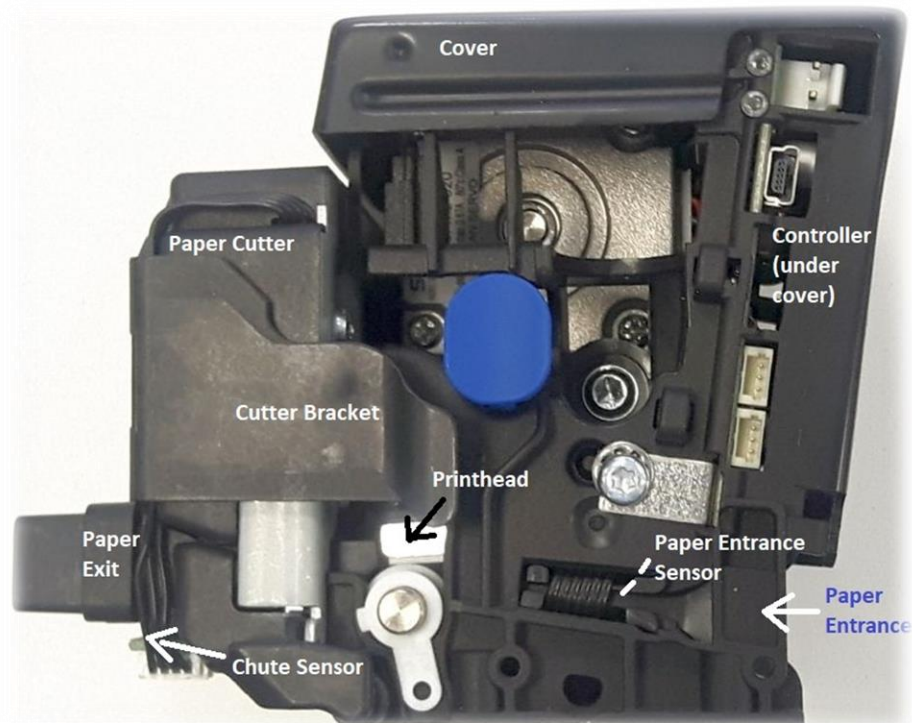

Figure 1

3.4. Description of Components and Operation

There are several key components or modules to the eXtendo® family of thermal printers (→Fig. 1). The thermal printhead is positioned above the platen. The platen acts as a roller to advance the paper at the same time it acts as a surface against which the spring-loaded printhead presses the paper to insure good thermal conductivity. The interface, motor used to turn the platen, sensors, printhead, and paper cutter are all connected to the controller, which controls all these components to function at the proper time and which also communicates to the host. The cutter separates the paper from the paper roll when instructed to do so. Several sensors monitor progress as the printed document is created. All these items are mounted in a conductive plastic housing to discharge any static and to provide electrical noise shielding.

The paper chute is a short chute protruding from the front of the printer. It snaps in and out without tools. The paper chute should be present for most normal printing applications, but it should be removed for applications where the printed document is expected to fall freely into a chute or other pathway. In these cases, the chute may interfere with the free fall of the printed document.

The paper entrance sensor detects if paper is approached in the entry area. The controller causes the motor to turn the platen to draw paper into the printer. As soon as the paper reaches the platen, the paper is pulled under the printhead and printing can begin.

While printing, the paper continues to advance and enters the paper cutter, where it passes between the cutter blades and out the print chute and passes the chute/jam sensor. Once printing is completed, the paper is advanced and a command sent to the cutter to cut off the paper. The paper then retracts to a park position to avoid wasting the paper between the printhead and cutter.

When the printer runs out of paper, the entrance sensor detects the fact. The controller then immediately stops printing and backs the paper up so it protrudes from the back of the printer. This is to allow the operator to raise the printhead, remove the partially printed document, and lower the printhead before loading a new roll of paper. If this were not done, it would be possible for short pieces of paper to remain in the paper path without the operator's knowledge, eventually causing an obstruction and a paper jam.

The chute/jam sensor located at the paper exit monitors whether there is paper in the chute. A more detailed description of this sensor can be found in chapter 3.6.5.

3.5. Location of Controls and Connectors

The following figures below show the locations of connectors, indicators and controls on the eXtendo® series.

- Figure 2 shows a USB version of the eXtendo® but also shows the alternative serial connector when using a printer with RS232 serial interface.
- Figure 3 shows the upper portion with details about the polarity of the power connector and cable.
- Figure 4 shows the opposite side of an eXtendo®, showing the Paper Advance Wheel and the Paper Low and Auxiliary Sensor connectors.

Please note that the Paper Pre-end/Paper Low Sensor connectors are optionally duplicated on the wheel side of the printer to make connection convenient regardless of which side of the printer might be near the cabinet side wall.

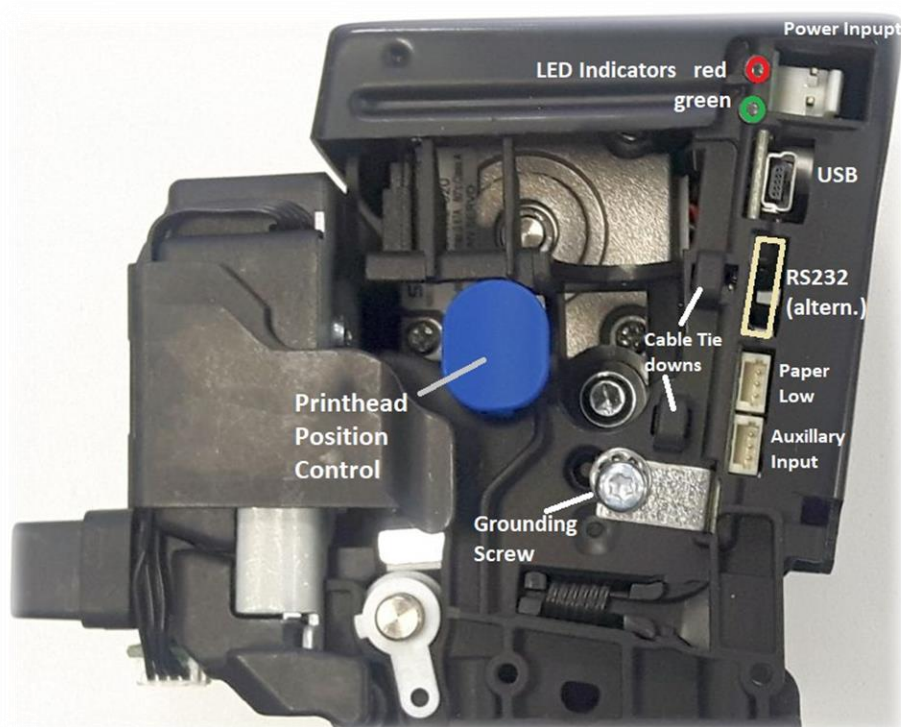

Figure 2

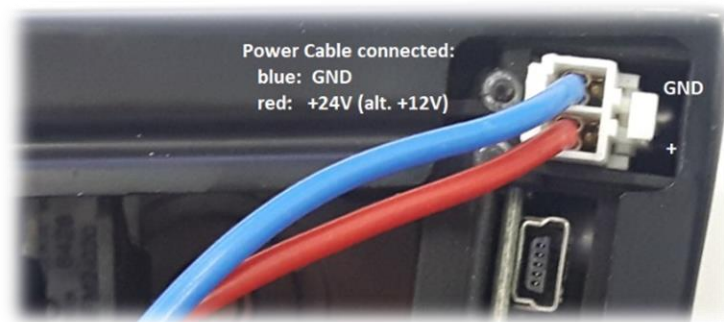

Figure 3

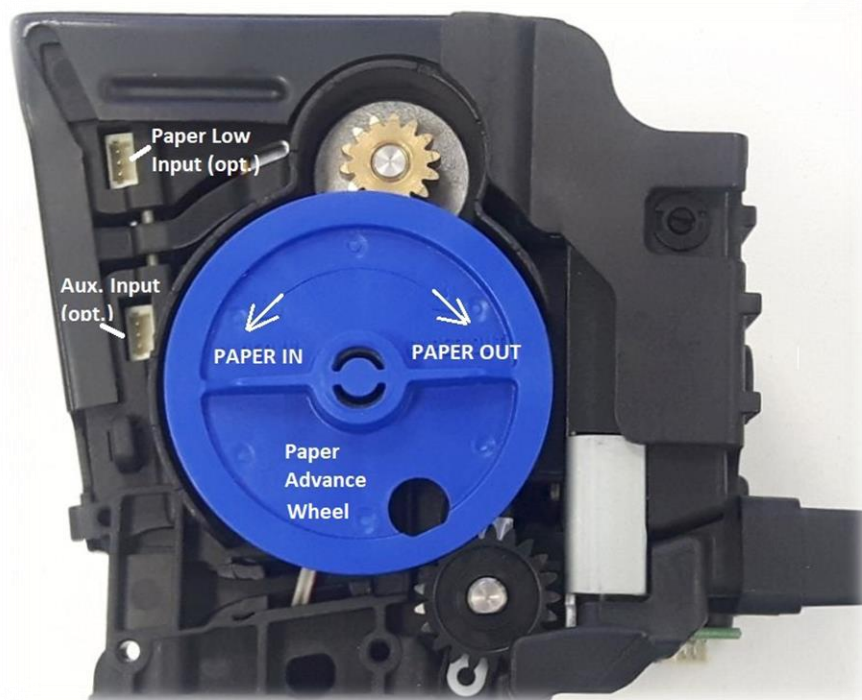

Figure 4

3.6. Operation of Sensors and LEDs

3.6.1. Paper Entrance / Black Mark Sensor

The basic function of the paper entry sensor in the paper entrance area has been described above. But the same sensor is also used to detect Black Marks. Black Marks are blackened areas placed on the paper during the converting process. They are generally used, in conjunction with appropriate printer commands, to advance the paper to a specific position after each print job. One common reason for this is to so that preprinted information is properly located with respect to information printed by the printer itself, for example, printing inside a preprinted box. Black marks can be located on the thermally coated side of the paper (where printing takes place) or on the back of the paper, depending upon the location of the sensor.

The eXtendo® series of printers is designed to allow for numerous Paper Entrance/Black Mark sensor locations during manufacturing (The location of this sensor cannot be changed once the printer is built). Also, two different sensor types can be used. The most common is the reflex or reflective sensor, where the light source and detector are located on a single chip. Basically, the

light strikes the white paper surface and reflects back into the sensor. If enough light reflects to activate the sensor, the printer concludes that paper is present. If there is not enough light reflected, the printer assumes that this area is black, meaning the printer is on a black mark or the printer is out of paper. There are six (6) different possible positions for this sensor in the X-56 and ten (10) in the X-80. Half of these positions sense the coated side of the paper, while the other half sense the back of the paper. The positions of these sensors are detailed in the Paper section of this document.

The eXtendo® can also use a through-beam sensor in OEM applications. This type of sensor has a light source on one side of the paper and the detector on the other side of the paper. When the light is blocked and cannot reach the detector, the printer concludes that paper is present. When the light does reach the sensor, the printer concludes that there is no paper present.

The through-beam sensor can also be used in a manner similar to a Black Mark sensor. Instead of a Black Mark, a hole is used in the paper. The through-beam sensor is located on the centerline of the paper path. This is the only location it may use.

3.6.2. Paper Pre-End (Paper Low) Sensor Option

When ordered with the Paper Pre-End Sensor option, the eXtendo® will be shipped with a paper pre-end sensor to be mounted by the customer. The sensor is a reflex type, meaning that it senses paper by bouncing light off the paper and detecting its reflection. The sensor is equipped with a 300 mm long cable to allow flexible mounting by the customer, and the sensor itself is mounted on a small printed circuit board with a hole to be used for mounting it. Simply mount the sensor where it will detect paper low (it is often mounted facing the side of the paper roll, so that as the diameter of the paper roll decreases, it eventually loses the reflection of the light and changes state), and plug the PPE sensor into the upper sensor connector on the control board. While the exact distance of the sensor from the paper varies from application to application, it is typically 2-5 mm for optimal sensing.

If the printer with a paper roll holder is ordered, the sensor comes pre-mounted to the paper roll holder and with the sensor connector plugged into the eXtendo® controller board. Figure 5 below shows the PPE sensor itself, while Figure 6 is the input circuit to the Paper Pre-End (Paper Low) input.

The lower sensor connector is for an Auxiliary Sensor, which can be mounted as desired by the customer. The status of this sensor or its input voltage reading will be reported when the printer's status is requested via the interface. The Auxiliary Sensor connector is located below the Paper Pre-End (Paper Low) Sensor connector.

Figure 6 shows the input circuit for these sensor connectors (Fig. 6 represents the circuit for either the Paper Low or Auxiliary Sensor; these two inputs are wired identically). Please note that each sensor input can have two connectors, a second one on the wheel side of the printer. The Paper Pre-End (Paper Low) Sensor connectors are designated CN6 and CN6', while the Auxiliary Sensor connectors are CN8 and CN8'.

Note: Only one connector of each pair (for example, CN6 and CN6') should be connected at one time.

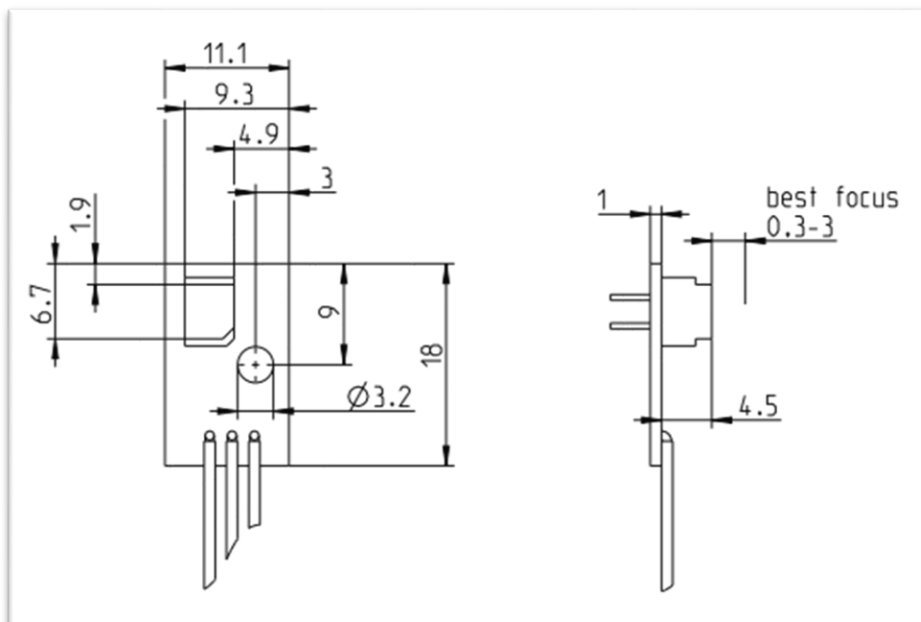

Figure 5 – Paper low sensor

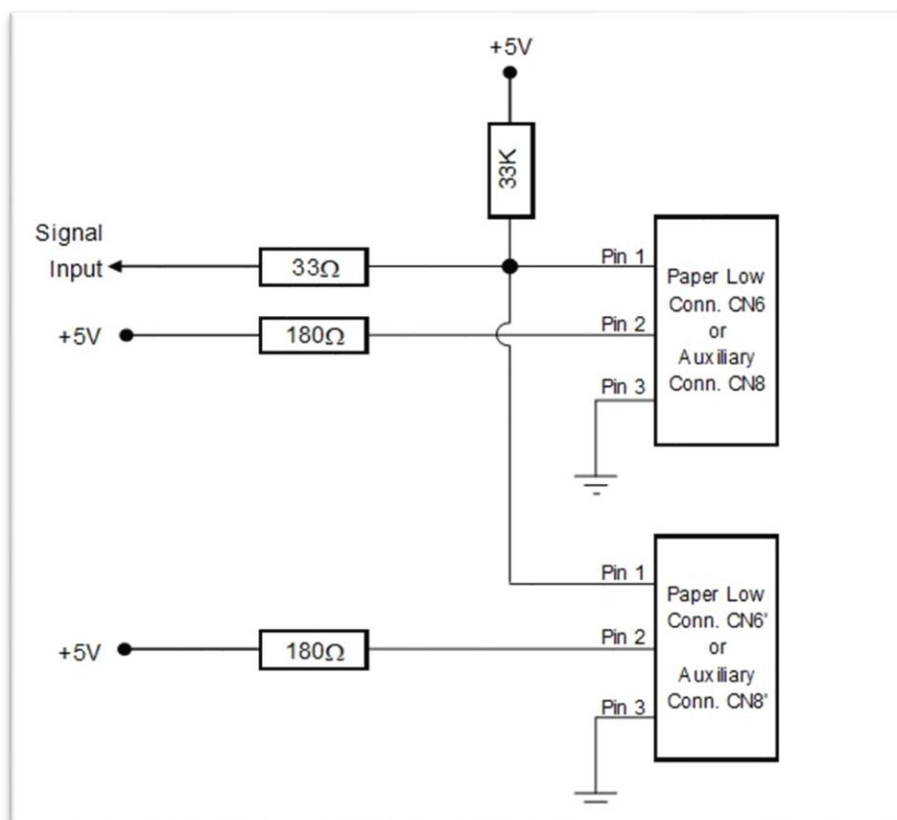

Figure 6 – Sensor Input Circuit

3.6.3. LED Indicators

There are two LED indicators in the eXtendo® series printers, located as shown in Fig. 2 and Fig. 3. The upper LED is red, and the lower one is green. These LEDs are used to signal various status information concerning the eXtendo® printer. There are several flashing speeds used in the printer LEDs. These are:

Slow:	0.5 Hz	(LED is “on” for one second and “off” for one second)
Medium:	5 Hz	(“on” for 100 ms and “off” for 100 ms)
Flicker (F):	10 Hz	(“on” for 50 ms and “off” for 50 ms)
0:		(off for 1 second)
1:		(on for 1 second)

Green LED	Red LED	Meaning
Slow	Off	Paper is loaded. Normal operation. Printer ready.
Medium	Off	Out of paper
Flicker	On	Data upload in progress (fonts, images, firmware, not normal data communication). Do NOT disconnect or power the printer off!
F 0 F	On	Printhead raised, printer stalled or over voltage
F 0 10 F	On	Paper error
F 0 10 10 F	On	Cutter error
Off	On	Boot failure
Flicker	Flicker	Initialization error
On	On	System “hung” during initialization



Please note that much more detailed information concerning the printer’s current state and sensor conditions can be obtained by requesting the printer’s status (→ eXtendo® Emulation Command Set Reference D 684 112) or by using the eXtendo® Diagnostic Tool.

3.6.4. Printhead Status Sensor

An additional Head Status Sensor is used to determine whether the printhead is in the up (do not print) or down position (ready to print). Normally, most of the heat generated by thermal printing is transferred to the paper being printed and so is removed from the head as the paper advances. When the printhead is in up position no printing or paper loading is possible. The output of this sensor as well as the current printhead temperature is also available from various query functions.

3.6.5. Chute/Jam Sensor

The chute/jam sensor continually monitors whether there is paper in the chute, and can be read via the Status function. This function is often used in conjunction with the host’s peripherals to signal the user when a printout has not been taken. Examples where this is important include when the information is confidential, or the printout can be redeemed for cash or items of value. This function can also be used to prevent the host from sending a new print job until the printout from the previous print job has been removed.

Additionally, the chute/jam sensor is monitored while first printing after a cut. After a cut, the printer “knows” where the end of the paper is. As printing takes place, the printer also “knows” when the edge of the paper should reach the sensor. If the paper does not reach the sensor when expected, the printer assumes that a paper jam has taken place and signals this fact via the Status command.



Note: Care must be taken when mounting the eXtendo printers to insure that the sensor is not exposed to direct sunlight. The multiple wavelengths of sunlight can cause false readings from this sensor. Therefore, always shield the chute and sensor from direct sunlight using chutes, shrouds, covers and similar techniques.

3.7. *Graphic Printing vs. Printing with Printer's Fonts*

One area that causes frequent confusion with regard to printers in general is that of graphic printing versus printing using the printer's internal fonts. An explanation here may help clarify this and make application of the eXtendo® easier for you.

All printers contain a set of commands that will cause the printer to perform different functions (For the eXtendo® family of thermal printers, these commands are documented in the eXtendo® Emulation Command Set Reference, p/n D 684 112). The functions are very diverse and there are no standards for what these functions may be. This allows printer manufacturers to innovate and build unique features into their products. These commands are often referred to as the printer's "Native Commands".

A printer's Native Commands are of many different types, but a few are of particular interest to us here. One is the family of commands for printing graphics. It is these commands that allow pictures and other graphic images of any type to be printed.

Another family of commands of interest to us here is the text commands. These commands involve printing text in response to ASCII data sent to the printer. The printer itself contains one or more character sets. In these character sets, one printable character corresponds to one ASCII character. There are also commands for positioning and modifying the printout from these character sets, such as tab and indent commands and commands to enlarge the internal characters by some factor.

When printing from the internal character sets (we'll call that "ASCII printing" here for convenience), characters are sent to the printer and the corresponding characters from the character set are printed. This has both advantages and disadvantages. The biggest advantage is that the host need only send one character per printed character. So if 40 characters are being printed on a line, for example, only 40 bytes of data (plus any overhead for formatting, indenting, etc.) need be transmitted over the interface. In other words, you can print a lot of text and need send only a little data. The downside is a lack of flexibility. In today's Windows® world, we are all used to printing exactly what we see on our computer screens, in the same font, size, etc. as we see it. But with ASCII printing, what will be printed will be based on the printer's internal character set.

The other type of printing we'll call "Graphic printing". This is what happens when you print to an ink jet or laser printer from your PC. The information displayed on the screen is sent to a print driver. This print driver, which is unique for each printer, translates what is on the screen as a graphic into graphic Native Commands to be sent to the printer. **Everything printed through a print driver prints as graphics.** It takes a lot more data to transmit graphics than to transmit ASCII. In our 40-character example, assuming a 12 x 20 pixel character, the eXtendo® X-80 printer would require 1,600 bytes (80 bytes/dot line * 20 dot lines) to print one "text" line (please note that these are estimates, and that various compression routines also impact the amount of data bytes).

The advantage of Graphic printing, then, is the ability to print anything; pictures, text, photos, etc. exactly as you see it on your screen. The disadvantage is that to do so, much more data must be sent over the interface.

If you are doing ASCII printing, you can use USB or a serial interface. Both are fast enough to handle the smaller amount of data being sent. But if you are doing Graphic printing, USB may be the better choice due to its higher speed, and serial may increase the time to complete a printout to an unacceptably long period.

3.8. *Features Selected at Time of Order*

One of the strengths of the eXtendo® family of thermal printers is that it allows the designer to select the features needed, rather than settling for performance less than desired or having to pay for features that will never be used. The current set of available options is listed below.

Feature Description	Option 1	Option 2	Option 3
Basic Unit	X-56	X-80	
Communications Interface	USB2.0	Serial (RS-232)	
Cutter	Twincut, Full and Partial Cut, up to 120 g/m ²	Twincut, Full Cut Only, up to 160 g/m ²	Rotary, Full Cut Only, up to 250 g/m ²
Environmental Range	0 to +50°C 25% to 80% RH, non-condensing	-25 to +70°C 20% to 100% RH	
Voltage	24 VDC	12 VDC (only for X-56)	
Paper Entry Sensor	Default BM Sensor location: Pos. 6 for X-56 Pos. 10 for X-80 (BM = black mark)	BM sensor located at one of the positions shown in Figure 13	Through-beam Sensor in center position
Paper Guides ¹⁾ Note: Standard on X-80	Not included	Included (2 pcs in a little bag)	
Paper Roll Holder ¹⁾ (including a Paper Pre End Sensor)	Not included	100 mm roll mounted on data connector side	100 mm roll mounted on gear side
		150 mm roll mounted on data connector side	150 mm roll mounted on gear side
Paper Chute ¹⁾	Included	Not included	
Paper Pre-End Sensor ¹⁾	Not included	Included (12 inch cable)	
Extended Warranty	Not included	3 year warranty	Other warranty conditions on demand

1) These components can also be ordered separately as accessories. See section “Spare Parts and Accessories”.

Due to the wide variety of options possible, it is necessary to be able to identify what features are included in each printer. Some features, such as the cutter or PPE sensor, are visually obvious. Other features such as software configuration and extended warranty, are not. Therefore, this data is stored as a code in each printer when it is manufactured.

5. Installation

5.1. Unpacking

Care should be taken when unpacking your eXtendo® printer to preserve the packing material for possible future use. eXtendo® packing is specifically designed to protect the printer from damage in the harsh environment of trucks and aircraft.



Please be sure to use this packing if it ever becomes necessary to reship your eXtendo® unit.

5.2. Function



Please note that the eXtendo® printer is a module designed to be integrated into a system and to be operated only as a part of that system, for example, in a kiosk. All technical specifications and

instructions contained in this manual and related documentation must be considered and complied with in order to achieve successful operation in the completed system.

5.3. Mounting Printer

The eXtendo® printer is built with four mounting holes for mounting from below, and four holes for mounting from the side. These holes are molded into bosses which are part of the plastic frame. Due to the very tough nature of the plastic used for the eXtendo®, we recommend the following screws for mounting the printer.

Side Mounting Holes: EJOT Delta PT30, max. penetration into the printer 8 mm

Bottom Mounting Holes: EJOT Delta PT40, max. penetration into the printer 8 mm

These screws are available from Hengstler as a “mounting kit” to simplify your sourcing needs. Hole layouts (viewed from above the printer) for mounting the X-56 and X-80 models with screws from underneath are shown below. Please refer to the drawings specified in section 1. 1 for more detailed dimensions and mounting hole locations for mounting from the side.

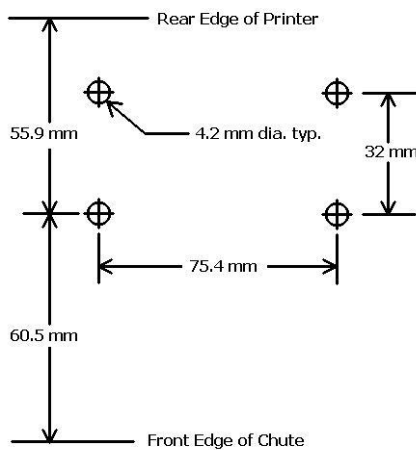

Figure 7a – X-56

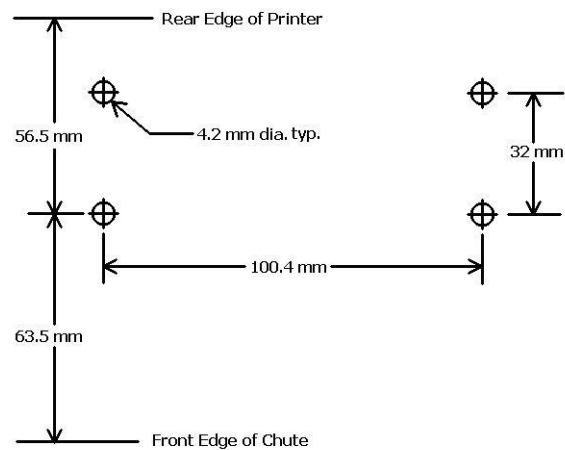

Figure 7b – X-80



Note: The eXtendo® printer is designed with a cutter cover (cutter bracket) that is hinged and can be tilted down to gain access to the cutter. However, the printer is designed such that this cover can be tilted down only if the printer is mounted at the edge of a shelf (→ Fig. 8). Attempting to lower this cover if the printer is back from the edge on a flat surface will likely damage the cutter cover! Please be aware of this when selecting your printer mounting location.

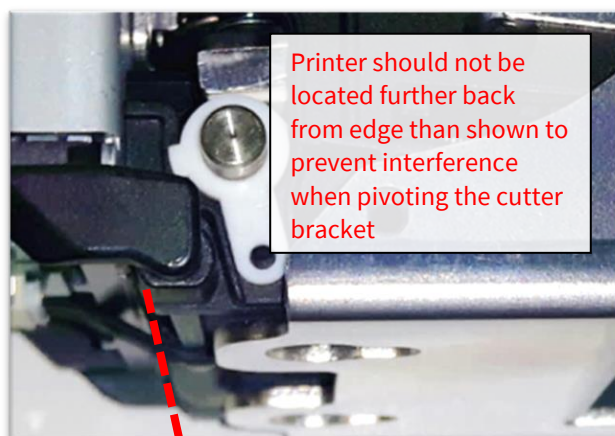

Figure 8

5.4. Installing Paper Guides

Depending upon the model and the options ordered, the eXtendo® family of thermal printers may come with a pair of paper guides. Since the paper guides are only used for certain width papers, and should not be used with other widths, they are not installed at the factory. Paper guides should be utilized as follows.

No. of Guides	Paper Width	Paper Width
	X-56	X-80
none	58-60 mm	84-86 mm
one	55-57 mm	81-83 mm
two	49-54 mm	60-80 mm

Use the following procedure to install paper guides. Please note that the cover has been removed from the printer to make it easier to see the paper guide area.

1. Locate the paper guides in a small bag packed with the printer and remove them. Note that the slotted, funnel-shaped opening is oriented towards the printer, and that the extended arms of the paper guide (→ Fig. 9) should point towards the middle of the printer. The paper guides are symmetrical and can be used on the left and right side equally.



Figure 9

2. Note that the paper guide has four tabs that are intended to engage the printer. Two tabs are at the end of the arms, and two tabs are near the slotted “funnel”. Locate the slotted area at the back of the printer (→ Fig. 10). Position the tabs on the funnel end in the middle of the slotted area of the side in which you will mount them, making sure to be clear of the gear teeth molded into the printer, then press down until these two tabs snap into place.

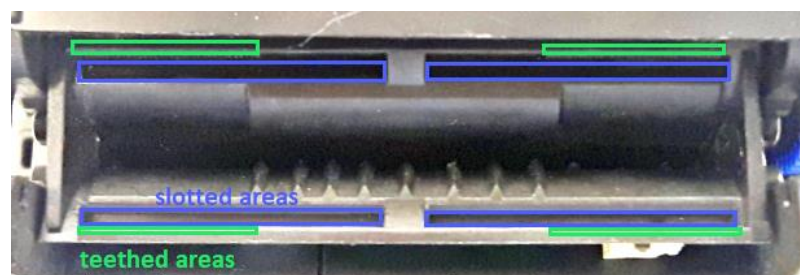

Figure 10

3. Slide the paper guide all the way to the outer edge of the slotted area. Press on first one, then the other of the arms to snap these two tabs into place.

4. The paper guide is now installed. Push or pull on the end of the paper guide to position it where desired (→ Fig. 11). You will hear the paper guide click as it locks into each position.

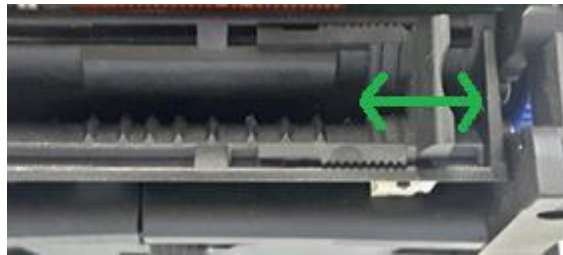

Figure 11

5.5. Wiring

5.5.1. Power

Power is connected to the eXtendo® thermal printer via a JST connector. The connector consists of a JST VHR-2N (RA 3. 96) shell and two SVH-21T-P1. 1 contacts. Wiring is as follows:

<u>Pin</u>	<u>Function</u>
1	0 VDC/GND (-) (blue wire)
2	24 VDC (+) (red wire)

The upper contact on the connector is common; the lower contact is the positive (+) voltage (→ Fig. 3).

Note: USB GND and power GND are connected to each other.



5.5.2. Data Interfacing

Serial

The printer is shipped with the following serial settings as default: 115,200 baud, 8 data bits, one stop bit, no parity, hardware flow control, and host transmission not blocked (this last feature is intended for use with lower sophistication hosts that cannot read the eXtendo® printer's status data. It uses the hardware handshake lines to prevent the host from sending more data if the printer registers "paper out").

The serial versions of the eXtendo® printer use a JST ZHR-6 connector shell with JST SZH-002T-P0.5 contacts to make the RS-232 connection. Hengstler can provide a serial cable for direct connection to PCs with a DB-9 connector on one end (→ section 13 *Spare Parts and Accessories*). Connections are as follows, should you decide to make your own connectors.

Serial Pinout

<i>DB-9 female</i>	<i>ZHR-6</i>	<i>I/O Function (Printer view)</i>
<u>Pin #</u>	<u>Pin#</u>	
8.....	1	RTS\
7.....	2	CTS\
5.....	3	GND (<i>internally connected to 0 VDC</i>)
2.....	4	TXD\
3.....	5	RXD\
--	6	n/c (<i>leave unconnected</i>)
1		n/c
4 		jumper to pin 6
6 		jumper to pin 4
9		n/c
Shell		Earth Ground

 Please note that the Hengstler cable is supplied with a flying pigtail on the printer end. This pigtail is intended to be fastened under the grounding screw, as shown in Fig. 2, to provide maximum reduction of radiated electrical noise.

 For additional protection against accidental cable removal, the cable tie-downs (→Fig. 2) are provided as a point to which you may fasten cables using cable ties (not provided).

USB

The USB versions of the eXtendo® printer employ a standard digital camera USB interface cable (5 pin Mini-B connector on the printer end) to communicate with the host. Be sure that the Mini-B connector is fully engaged with the mating connector on the printer. The other end of the cable plugs into a USB port on the host.

USB Pinout

<i>Pin</i>	<i>Signal name</i>	<i>I/O Function</i>
<u>Number</u>		
1	NC	no connection
2	D- I/O	Data -
3	D+ I/O	Data +
4	NC	no connection
5	SGND	I/O Signal GND (<i>internally connected to 0 VDC</i>)

 Please note that the shell of the USB connector automatically makes a connection to the earth ground screw as shown in Fig. 2.

5.6. Paper Supply

5.6.1. Hengstler Paper Roll Holders

Hengstler offers two paper roll holders for use with the eXtendo® family of thermal printers. One is a small holder intended to position 100 mm rolls of thermal paper in various positions behind or below the printer. The second paper roll holder is intended for paper rolls up to 150 mm diameter, and otherwise has similar characteristics to the 100 mm version. Both paper roll holders usually come with a paper pre-end sensor installed.

5.6.2. Designing Your Own Paper Roll Holder

It is sometimes desirable for customers to design their own paper roll holder in order to fit in the available space, or to tailor performance to their specific needs. Based on our extensive experience in designing printers, we would urge you to consider the following topics and implement your design with care.

Large Diameter Rolls: When using paper rolls over 100 mm in diameter, a “dancer bar” should be considered. This usually takes the form of a spring-loaded arm under which the paper is placed before feeding it into the printer. As the printer starts to print, slack is taken up from the paper roll. This starts to lift the arm against the spring, which puts force on the paper roll and starts it moving slowly. As more printing takes place the roll gradually accelerates until it’s up to printing speed. Without the dancer bar, slack paper would be taken up until it was suddenly no longer slack. Now the printer must accelerate a large, heavy paper roll from zero speed to full print speed in essentially no time. This usually causes the paper advance motor to stall or the paper to slip against the platen, causing shortened characters until the paper roll is up to speed.

Spindle Friction: Another important consideration is spindle friction. As a paper roll rotates, it slides against the spindle that holds it, assuming a fixed spindle. This friction will tend to impede the paper roll’s free motion, and is dependent upon the weight of the roll, the smoothness and material of spindle and paper core. When possible, especially with paper rolls over 100 mm in diameter, design the spindle so that it can rotate, greatly decreasing friction and drag.

Catch Points: More paper jams and transport problems are caused by catch points than any other issue. Make sure that the paper path is free of anything that can interfere with free paper flow, especially any sharp edges or “pinch points” into which the paper may stray and become caught.

Alignment: Any paper roll holder design must hold the paper square to the printer in all planes. If the paper is angled in any way, it will enter the printer at an angle and will be more likely to cause paper jams.

Rigidity: It is important that the paper roll holder support the paper firmly and not move. This is especially true in high-speed printing applications and in large diameter paper roll applications. Many paper roll holders are made from metal too thin to support the heavy paper rolls they are expected to handle. This results in twisting and warpage while printing, which binds the paper and causes paper jams. Vibration during printing may also cause undesired movement of the paper roll.

Shipment: Do not ship your product with a paper roll mounted in the paper roll holder. The heavy weight of the paper roll can easily bend or otherwise damage the paper roll holder or printer, as witnessed numerous times.

5.7. Power Supply Specifications

Selection of a power supply for thermal printers depends upon the printer's application, what percentage of the printout is black, frequency with which printouts are generated, and more. In particular, thermal printers draw high currents for very short time periods. The most important issue is not peak current, but the length of time that the power supply is able to deliver instantaneous current over its rated maximum, and for how long the print job prints high black percentages, thereby drawing high current. It is important that the power supply's over-current system does not shut down the power supply when these brief, high current surges occur.

With that said, we recommend the following power supply specifications for most 24 VDC applications. Please see the "Technical Specifications" section near the end of this document for full details on the various voltages available.

DC Output Voltage: 24 volts \pm 5%

DC Output Current: 4 amperes (=100 Watts nominal)

Hold Up Time: 20 ms minimum

Current Limitations: 16 Ampères minimum

5.8. Electrical Design Aspects

An important aspect of the electrical design is about grounding. The high currents during printing require a solid grounding concept. Typically, the power supply for the printer and for the computer are separate units with individual grounding. Therefore, the more important it is to keep both grounding levels closely together.



It is recommended to locate common groundings as close to the printer power connection as possible rather than at the power supply location. High currents can generate high voltage shifts over long supply wires. Such high voltage shifts of up to several Volts may cause high compensation currents that search way through the communication cable (USB, RS232) from the printer to the computer leading to distortions in communication or even damage of components.

6. Operation

6.1. Loading Paper

The eXtendo® series of thermal printers automatically loads paper when it is inserted. First, make sure that the printhead is in the “down” position by pulling the Printhead Position Control to the outer position. Then insert the paper, thermosensitive side up, into the paper slot in the rear. You will hear the paper feed motor start to run as soon as the paper detection sensor is reached. Continue to feed the paper until the platen grasps it and pulls it into the printer.

Please note that the eXtendo® thermal printer family will, unless specifically configured not to do so, print an Information Report immediately when paper is loaded. An of an Info Printout is shown on the right. This short report is extremely helpful during setup and configuration of the eXtendo® printer. This report contains detailed information concerning the printer itself, date of manufacture, its features, the firmware installed, the status of information in the flash memory, and many other settings that configure the printer itself.

One example of how this report can be used involves the serial version of the eXtendo® printer family. If you want to verify the current serial settings (baud rate, stop bits, parity, etc.), simply remove and reload the paper. RS232 settings are printed as part of the Info Printout. Please note that many of the software tools supplied with the eXtendo® driver also allow this report to be printed by command without removing the paper. Simply click on the “Print Info” button.



HINT: In case the automatic Info Printout is disabled on your printer, you can generate a report when you push the blue printhead control (→ Fig. 2) in and pull it out three times.



The eXtendo® thermal printer family is designed to use paper with the thermosensitive side on the **outside** of the paper roll. This is important as the printer is optimized to deal with paper curl angling the paper end downward.

6.2. Printhead Position Control

The printhead position control (→ Fig. 2) is used to raise and lower the thermal printhead. This control moves in and out of the side of the printer, and has two positions. The “out” position lowers the printhead to the platen so that the printer is ready to print. The “in” position raises the printhead off the platen. The printer is shipped with the printhead in the “in” raised position; it must be lowered to the “out” “ready to print position” for use.

Leaving the printhead in contact with the platen for a long period of time without paper under the printhead may cause a temporary indentation in the platen, which can result in initial feeding difficulties. If this occurs, simply push the Printhead Position Control in to raise the printhead, insert paper, and then pull the Printhead Position Control out while the motor is running.

6.3. Paper Advance Wheel

The eXtendo® family of printers is equipped with a Paper Advance Wheel to make it simple to manually advance paper when needed (→ Fig. 5). Rotating this wheel counterclockwise (the direction labeled “Paper In” on the wheel) will draw paper in from the paper supply at the rear of the printer. Rotating the

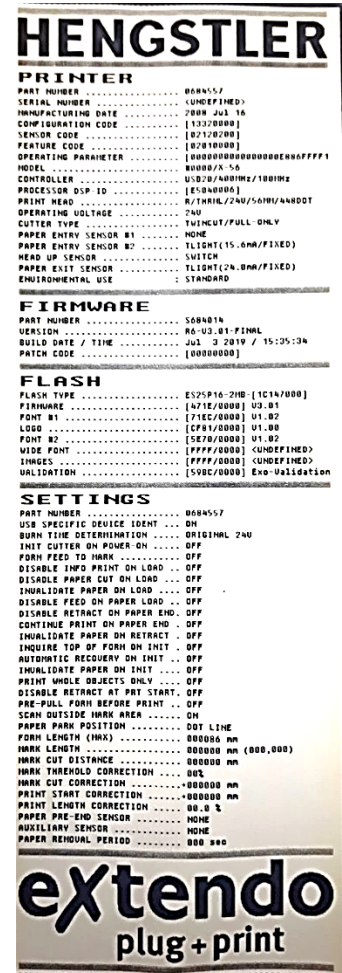

wheel clockwise (the direction labeled “Paper Out” on the wheel) will cause paper to back out of the rear of the printer.

Note: Under normal conditions, the Paper Wheel will not be used. Paper must be loaded with the automatic paper load function in order to be detected properly. See *6.1 Loading Paper*.

6.4. Print Speed

Print speed is affected by many factors. First, the maximum print speed is dependent upon the operating version of the eXtendo® version that you ordered. Even with the maximum print speed in the firmware set to 350 mm/sec, the 12 Volt models will not exceed 130 mm/sec. Other significant factors affecting print speed include:

- Type of interface / ASCII printing vs. Graphics printing
- Data transmission rate (serial)
- Density settings
- Dot history factor
- Multi-strobe factor

6.5. Cutter Operation

The cutters used in the eXtendo® series printer are either Twincut guillotine types or rotary cutter types, depending upon what is ordered. All types are motor driven and use internal cam action to provide feedback as to when the cutter has returned to its home position. Twincut versions with full and partial-cut capability can make full or partial cuts under software control. Technical specification sheets on standard versions of the cutters themselves are available upon request from Hengstler.

Please note that, when dealing with an eXtendo® with the Twincut guillotine cutter, the cutter blades can be manually moved without removing the cutter cover. Simply insert a small, flat bladed screwdriver in the screw slot located in the area circled in Fig. 12, and turn. This will manually turn the motor, moving the blades. This is useful in clearing paper jams.



Please be sure to remove power from the printer before moving the cutter blades, and keep your fingers clear of the blades themselves.



Figure 12

6.5.1. Partial Cut with Chute Sensor



The behavior of the eXtendo® family of printers when using the full- and partial-cut guillotine version of the cutter is different when a partial-cut is made and the printer is equipped with the chute sensor. With the sensor, the platen motor is locked after the partial cut is made to make it easy to tear the remaining paper tab and to prevent vandals from pulling the paper off the paper roll inside the printer. After approximately 30 seconds, if the sensor detects that the paper has not yet been taken, the printer will do a full cut to foil any vandals.

When the printer is not equipped with a chute sensor, the partial cut function is not recommended because there is no means in detecting “receipt taken”.

6.6. eXtendo® Digital Tools

The eXtendo® family of thermal printers includes with the Windows XP driver a series of very useful tools. These can be run directly from the Tools folder of the driver package once the driver has been installed. A brief summary of some of the tools is as follows.

eXtendo® Configuration Tool: A very important tool that allows you to change virtually any variable setting or performance characteristic of your eXtendo® printer, e.g. format control parameters, default print speed, dot history etc.

eXtendo® Command Tool: Very simple tool for sending Native Commands to the printer. Can be used to experiment and build complete ticket sequences.

eXtendo® Print Terminal: Possibly the most useful tool of the bunch, the Print Terminal has 12 sets of 24 buttons each, part of them pre-programmed with useful commands. All buttons are programmable to make them transmit whatever is needed by a single click. It also provides a display that show the transmitted data as well as the printer’s responses, e.g. upon status request commands. Both, Command and Print Terminal Tools are very popular with software developers who are integrating the eXtendo® into their products.

eXtendo® Diagnostic Tool: A useful tool for identifying possible issues with your printer, its peripherals and firmware. Provides all sensor information as well as a test bench for endurance testing.

eXtendo® Font Tool: Used for uploading and assigning different fonts within the eXtendo® printer. You can modify fonts or use pre-defined code page bundles.

eXtendo® Image Tool: This tool creates eXtendo® upload files from standard graphic files so they can be uploaded as stored images.

eXtendo® Uninstaller Tool: Use this tool to uninstall single or all versions of the eXtendo® driver.

eXtendo® Upload Tool: Used to upload firmware and other upload files (image/logo files, font files) to the flash area of your eXtendo® printer.

eXtendo® Wide Font Tool: Used for creating Wide Font formats (such as Chinese or Korean) from standard graphic files.

7. Low Current Operation

There are numerous factors that affect thermal printer current. It is possible to manipulate these factors consciously to reduce current draw for situations where this is important, such as operating from batteries. If battery operation only occurs when power has failed, the host software can be programmed to print at a faster, higher current rate during normal operation and then switch the eXtendo® to a lower current mode when the system switches to battery operation. The following are some considerations to aid in reducing current draw.



For all items described in the following, please refer to the eXtendo® Emulation Command Set Reference D 684 112 or the eXtendo® Configuration tool for a comprehensive view.

7.1. *Print Speed*

With thermal printers, average current is about proportional to print speed. Since the burn time for each dot row is fixed, when printing slower there is more pause between burns and therefore a lower average current. The eXtendo® target print speed can be set via command or the configuration. The slower this print speed is, the lower the current draw will be. Note that when printing via the eXtendo® Windows driver, print speed and density settings come from the settings of the driver (see under “Devices and Printers”) and overrule the the printer internal settings.

7.2. *Graphics/Bar Codes*

Printing graphics typically consumes more current than printing only text. Text-only printing is considered to be ~15% coverage on average, while graphic or barcode printing may go up to 50%, consuming 2x to 4x the average current. In terms of current draw, it does not matter whether printing is done using the printer’s internal character set and barcodes or whether printing goes via the graphical driver.

7.3. *Inverse Printing*

Inverse text printing should be avoided when current matters, since everything that’s normally black becomes white, and vice-versa, is drawing (in average text) about 6 to 8 times the current.

7.4. *Dot History Factor*

Dot history monitors previously burned dots and reheats them for a shorter time to prevent blooming and excessively black areas, thereby decreasing total current consumption. Using dot history can help reduce average current draw but primarily increases print image sharpness.

7.5. *Multi-Strobe Factor*

This feature is an eXtendo® software feature that will reduce **peak** current. When the double-burn feature is turned on, only half of the printhead is fired at a time, reducing the peak current by ~30..40%, but having virtually no effect on average current. This is useful if your power supply or connectors have a restrictive maximum current, but note that it limits the print speed.

7.6. *Print Density Adjustment*

Increasing print density will improve print quality / blackness, but at the same time will increase current draw. Therefore Print Density is always a trade-off between these two characteristics. Use the lowest print density that is visually acceptable to minimize current draw.

8. Troubleshooting

Symptom	Possible Cause	Corrective Action
No LEDs light on printer	<ol style="list-style-type: none"> 1. Power not connected 2. PCB mounted fuse blown (typically after reverse polarity of DC power) 	<ol style="list-style-type: none"> 1. Check line cord and outlet 2. Return printer for repair; not field replaceable unless authorized individually.
LEDs flashing	See Section “LED Indicators”	See Section “LED Indicators”
Printer will not feed paper	<ol style="list-style-type: none"> 1. Print head raised (LEDs will flash; see Section “LED Indicators”) 	<ol style="list-style-type: none"> 1. Pull out the blue print head lever
Printer will not load paper and makes loud noise	<ol style="list-style-type: none"> 1. Printer left with no paper under printhead 	<ol style="list-style-type: none"> 1. Raise printhead, manually turn blue wheel, lower printhead
Printer prints blank paper	<ol style="list-style-type: none"> 1. Paper inserted upside-down 2. Wrong side of roll coated 	<ol style="list-style-type: none"> 1. Invert paper roll 2. Invert roll as test, have paper made properly
Print quality poor	<ol style="list-style-type: none"> 1. Print density set too low 	<ol style="list-style-type: none"> 1. Adjust print density settings, other burn time adjustments.
Baud rate, other configuration setting changes not effective after use of Configuration Tool	<ol style="list-style-type: none"> 1. Printer and computer not reset/rebooted after changes made with Configuration Tool or on computer COM port. 	<ol style="list-style-type: none"> 1. Reset printer. 2. Reboot computer for COM: settings to take effect. Alternatively run “net stop spooler” and “net start spooler” in a command window.

9. Maintenance

The eXtendo® printers are intended to be maintenance-free, and as such do not require any regular service or maintenance.

10. Repair and Support

For details, and to arrange for the return of a printer for repair, please contact us by using the online RMA procedure which you can find on our webpage (<https://www.hengstler.de/de/support/reparaturanfrage.php> or https://www.hengstler.de/en/support/repair_request.php).

After providing all basic information in the RMA form, you will receive instructions and a shipping label for your package.

If you need technical support or help you will also find contact information on the webpage described above. When you click on the tab “Support”, you can find an online form that you can fill in and send to the Hengstler support team. You will also find a phone number where you can speak to a support team member during business hours.



Please have part number “0684...”, serial number and date of manufacturing available. These can be found on the product label. In many cases it is also helpful to know the firmware version. All needed information can also be found on the Information Printout of your eXtendo® printer

11. Buying Paper

11.1. Sourcing Paper

In order to maintain your warranty, use only paper that conforms with eXtendo® Paper Specification D 684 122. Use of paper that does not conform with this specification may adversely affect the performance of your eXtendo® printer and/or damage your printer. Please note that the eXtendo® can use either roll or fanfold paper. When using fanfold paper, care must be taken to configure the printer, black or hole mark, and positioning so that the cut always occurs **after** the fanfold bend, not on it or before it. Failure to do so will cause cutting problems and will likely increase paper jams.

Converting Paper

Thermal paper is usually purchased through paper converters. These companies buy large, jumbo rolls of specific paper types from the few true paper manufacturers in the world and then cut it and roll it to your specifications. You may elect to have preprinting or black marks added at this time, as well. Please make sure that any paper a converter wishes to supply you for use with your eXtendo® printer conforms with eXtendo® Paper Specification D 684 122.

11.2. Black Mark Sensor Locations

The Black Mark (BM) sensor of the eXtendo® printers can be located in numerous positions during manufacturing, both above and below the paper. Figure 13 represents X-56 and X-80 paper, and show where the BM should be located in order to be detected with the BM sensor of your eXtendo® printer. Grey/dotted areas reference locations on the back (bottom) side of the paper. The number inside each black mark area is the BM Position number and refers to the printer's match code that you would see on quotations, invoices etc. (e.g. X56-S-F-06-J-.. here an X-56, Serial Interface, BM sensor at location 6).

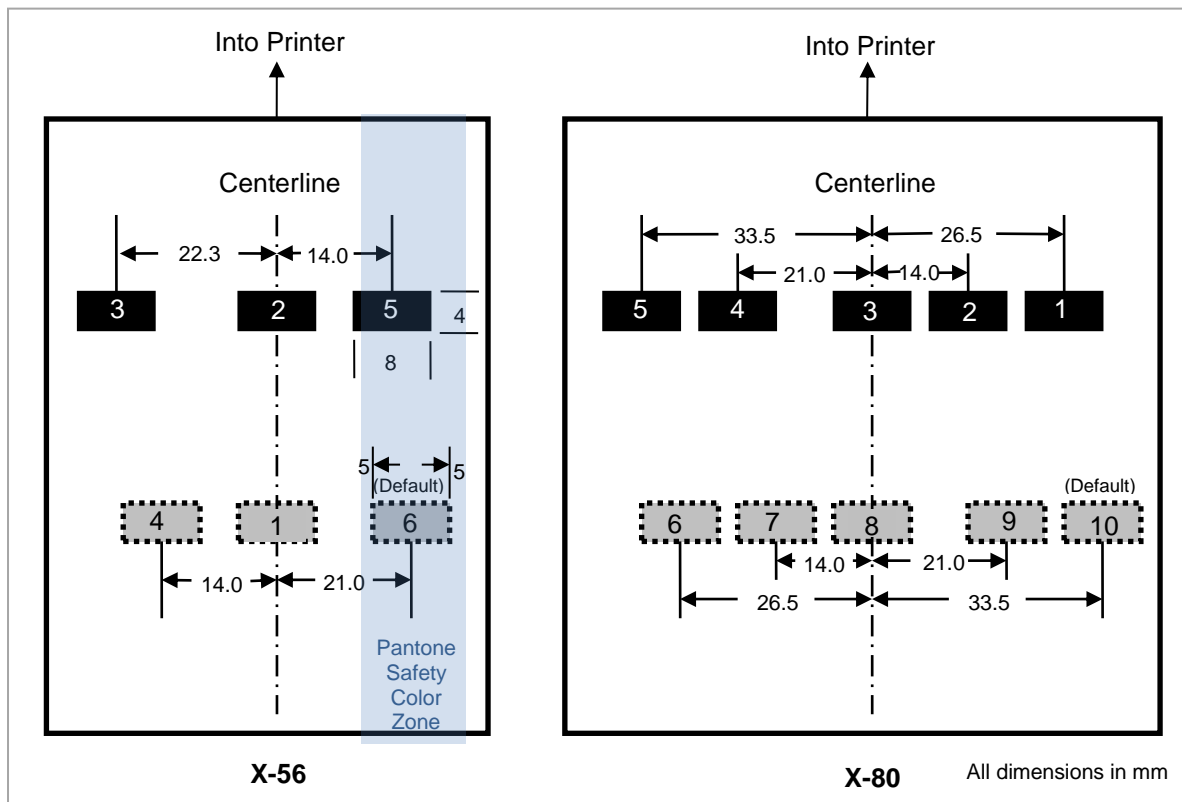

Figure 13 – Sensor Positions (top view on thermal layer)

The center position **1-2** for X-56 and **3-8** for X-80 can be employed for a through-beam sensor. See also section 3.6.1 *Paper Entrance / Black Mark Sensor*.

Default BM sensor locations:

X-56	BM sensor 6	(bottom side)
X-80	BM sensor 10	(bottom side)

Please note that sensor locations other than the default location are intended for OEM applications.



In order to avoid accidental interpretation of preprinted information as the black mark, it's necessary to keep the area 5 mm to the left and right of the BM edges for the entire length of the printout free of all printing except Pantone Safety Colors with a print contrast (PCS) value of under 15%, as measured by MacBeth RD924. The BM itself must have a print contrast over 80%, per DIN 66223, measured with MacBeth PCM2, Filter B. This applied to the side of the printout where the BM is located, regardless of whether it is the thermal-coated side or not. The blue area in Fig. 13 shows this zone for the default sensor position 6 of the X-56.

12. Technical Specifications

12.1. General Specifications (X-56 and X-80)

Technology:	Direct Thermal
Resolution:	203 dpi (8 dots/mm)
Paper Weight:	50 to 120 g/m ² (Twincut cutter; partial/full cut model) 50 to 160 g/m ² (Twincut cutter; full cut only model) 50 to 250 g/m ² (Rotary cutter, full cut only)
Cutter:	Guillotine (full or partial cut) or Rotary Type (heavy stock)
Interface Types:	a) USB 2.0 industrial Interface cable length 3 meters max. Transmission rate: 1.5 Mbit/sec and 12 Mbit/sec b) RS-232 Interface cable length 3 meters max. 4,800 to 115,200 baud
	DC supply cable length max. 3 meters. No DC building power supply; compare warnings in <i>section 12.4 Electromagnetic Compatibility</i> on pg. 33.
Bar Codes:	
<i>Internally Generated:</i>	UPC-A, UPC-E, EAN-13, EAN-8, Code 39, Interleaved 2 of 5, Code 128, Codabar 2D: PDF417, QR Code, Datamatrix, Aztec
<i>Externally Generated:</i>	Any, generated by the application program using GDI printing
Minimum Print Length:	15 mm. Note: At a length of 15 mm, the paper will not be visible at the end of the paper chute. Print at least 40 mm for the paper to be visible. The 15 mm minimum length is included to allow for applications where the printer is ordered without the chute and where very short printouts may be dropped into a bin or similar conveyance.
Temperature Range	
<i>Operating:</i>	-25°C ... +70°C, 20% ... 100% RH (extended range) or 0°C ... +50°C, 25% ... 80% RH, non-condensing
<i>Storage:</i>	-30°C to +75°C
Printhead Life	
<i>Abrasion:</i>	150 km of paper (<i>based on 12.5% print density</i>)
<i>Electrical:</i>	150 million dot pulses
Paper Roll Capacity:	Optional Roll Holder with up to 150 mm (6 inch) roll diameter Customer Roll Holder up to 300 mm (12 inch) (reduced performance; debouncing mechanisms recommended)
Graphic Driver:	Windows® 7/8/10, Linux (CUPS, ARM, 64-bit)
Firmware:	Field upload able
UL - Certificate:	E174318
Shock and Vibration:	Vibration: DIN EN 60068-2-6 Shock: DIN EN 60068-2-27 (for shipping purposes)

12.2. X-56 Specifications

Print Speed: 24 VDC: 350 mm/sec (13.7 ips) max.
 12 VDC: 130 mm/sec (5.1 ips) max.

Paper Width: 49-60 mm (1.93 to 2.36 inches)

Printable Width: 56 mm (2.20 inches)

Operating Voltage: 24 VDC ±5% or
 12 VDC (11-15 VDC)

Duty Cycle: 24 VDC: Thirty (30) 150 mm long printouts per minute max.
 12 VDC: Fifteen (15) 150 mm long printouts per minute max.

Current Draw:
 In standby, approx.: 50 mA

While printing: @21°C, print speed 100mm/s; current in **Amps avg.**

	Print density (pixel coverage)		
	12.5%	25%	50%
24 VDC	1.0	1.6	2.8
12 VDC	0.9	1.5	2.6

Dimensions (W x H x D): 100 x 92 x 120 mm (approx.)

12.3. X-80 Specifications

Print Speed: 24 VDC: 350 mm/sec (13.7 inches/sec) max.

Paper Width: 60-86 mm (2.36 to 3.38 inches)

Printable Width: 80 mm (3.15 inches)

Operating Voltage: 24 VDC± 5%

Duty Cycle: 24 VDC: Thirty (30) 150 mm long printouts per minute max.

Current Draw:
 In standby, approx.: 50 mA

While printing: @21°C, print speed 100mm/s; current in **Amps avg.**

	Print density (pixel coverage)		
	12.5%	25%	50%
24VDC	1.4	2.3	4.0

Dimensions (W x H x D): 130 x 92 x 120 mm (approx.)

Please refer to the appropriate drawings listed in section 1.1 of this document for detailed dimensions.

12.4. Electromagnetic Compatibility

12.4.1. FCC Part 15 Class B Device

NOTE: This equipment has been tested and found to comply with the limits for a Class B digital device, pursuant to Part 15 of the FCC Rules. These limits are designed to provide reasonable protection against harmful interference in a residential installation. This equipment generates, uses and can radiate radio frequency energy and, if not installed and used in accordance with the instructions, may cause harmful interference to radio communications. However, there is no guarantee that interference will not occur in a particular installation. If this equipment does cause harmful interference to radio or television reception, which can be determined by turning the equipment off and on, the user is encouraged to try to correct the interference by one or more of the following measures:

- Reorient or relocate the receiving antenna.
- Increase the separation between the equipment and receiver.
- Connect the equipment into an outlet on a circuit different from that to which the receiver is connected.
- Consult the dealer or an experienced radio/TV technician for help.

12.4.2. EN55032 – Emissions

The eXtendo® family of thermal printers are class “B” appliances, and comply to applicable Class “B” standards, when installed in a properly grounded housing with appropriate conductive shielding.



When operating the printer from a DC building power supply, or when the DC power cable or data cable exceeds 3 meters in length, appropriate EMI filters must be used.

12.4.3. EN55035 – Electromagnetic Susceptibility



Electrostatic discharges and burst effects may cause short printing interruptions, but the automatic recovery function of the printer will restore it to its original state.



Additional action regarding lightning and overvoltage protection will be needed if cables and wires are installed outside of a building.

However, this standard can be met only if original units, components, and cables are used and the installation instructions are respected and followed completely.



External interference caused by ESD or EMI can temporarily cause corrupted printing or data loss.

13. Spare Parts and Accessories

Description	Hengstler part #
Serial Data Cable, 2 meter long (9-pin Sub-D to eXtendo)	E1684527
USB Data Cable (Mini-USB), 1.5 m	0684102
DC Powercable with connector and pigtail, 1.0 m	E1684530
Mounting Screws, kit of 2x4 (4x bottom mount and 4x side mount)	E1684501
Paper Guides (kit of 10 pcs)	E2684087
Paper Holding Clip (kit of 10 pcs) <i>mounts together with chute, for paper >100 gr/sqm</i>	E2684266
PPE-Sensor with 12 inch / 300 mm cable	E1684115
PPE-Sensor with 22 inch / 550 mm cable	E1684133
Paper Roll Holder, X-56, 4inch roll, mount at Data side, w/PPE sensor	E1684540
Paper Roll Holder, X-56, 4inch roll, mount at Gear side, w/PPE sensor	E1684541
Paper Roll Holder, X-56, 6inch roll, mount at Data side, w/PPE sensor	E1684542
Paper Roll Holder, X-56, 6inch roll, mount at Gear side, w/PPE sensor	E1684543
Paper Roll Holder, X-80, 4inch roll, mount at Data side, w/PPE sensor	E1684840
Paper Roll Holder, X-80, 4inch roll, mount at Gear side, w/PPE sensor	E1684841
Paper Roll Holder, X-80, 6inch roll, mount at Data side, w/PPE sensor	E1684842
Paper Roll Holder, X-80, 6inch roll, mount at Gear side, w/PPE sensor	E1684843
Paper Roll, 60 mm wide, 55 g/sqm, outer/inner Ø 100 / 25.4 mm	3810859
Paper Roll, 80 mm wide, 55 g/sqm, outer/inner Ø 100 / 25.4 mm	3810862